

pottery barn kids

THOMAS TRUNDLE

PRE-ASSEMBLY:

- Remove all parts and hardware from the box and lay out on a clear carpeted or scratch-free work surface, as this will avoid damaging parts during assembly. The shipping box provides an ideal work surface. Do not dispose of any contents until assembly is completed to avoid accidentally discarding small parts or hardware.
- Two adults recommended for ease of assembly.
- Use the parts and hardware lists to identify and separate each of the pieces included prior to starting assembly.
- The illustrations provided allow for easier assembly when used in conjunction with the assembly instructions.
- Note: Do not fully tighten all bolts until all parts are in place. Failure to follow these instructions may cause the bolts to misalign during assembly.
- If using power tools to aid in assembly please use caution. Power tools can damage hardware or split wood.

PARTS INCLUDED:

(A) Long siderail w/o profile – 1pc

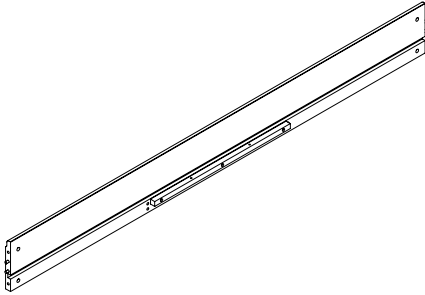

(B) Long siderail with profile – 1pc

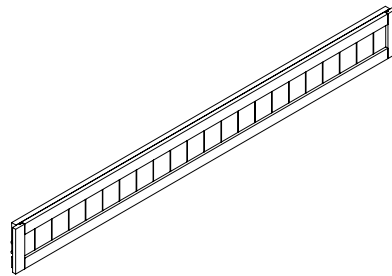

(C) Short siderail Side – 2pcs

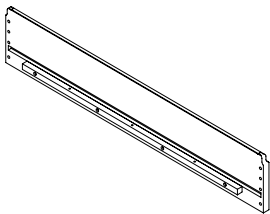

(D) Side bottom board with protruding edge – 2pcs

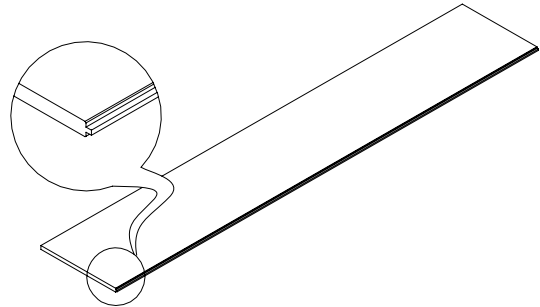

(E) Middle bottom board with sunken edge – 1pc

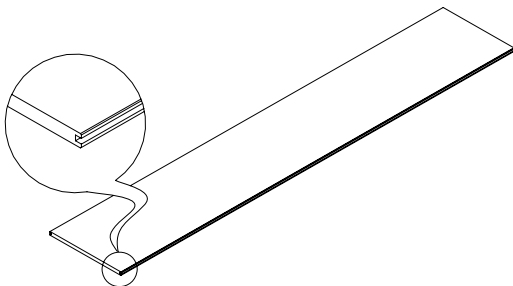

(F) Wooden bottom board support – 2pcs

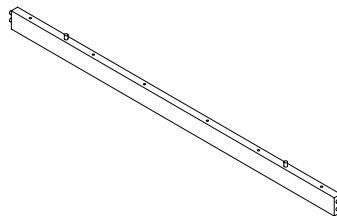

HARDWARE ENCLOSED:

(G) Large Phillips head screw 8x38mm – 12pcs

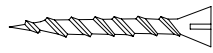

(H) Allen Key – 1pc



(I) Long bolt 1/4"x2-1/2"x13.5mm – 8pcs

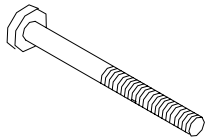

(J) Barrel nut 1/4"x15x9.5mm – 8pcs

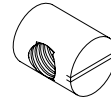

(K) Small Phillips head screw 8x25mm – 10pcs

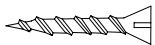

(L) Pan head screw 8x17mm – 24pcs



(M) Caster 50x50x65mm – 6pcs

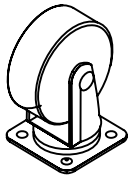

TOOLS REQUIRED:
Phillips screw driver (not included)

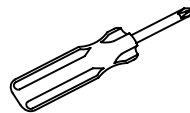

ASSEMBLY INSTRUCTIONS:

1. Slot the Middle bottom board (E) into the (2) Side bottom boards (D). Attach the Wooden bottom board supports (F) to middle bottom board (E) and Side bottom board (D) to the assembly as shown using (12) Large Phillips head screws (G) . (Fig. 1)

(Fig. 1)

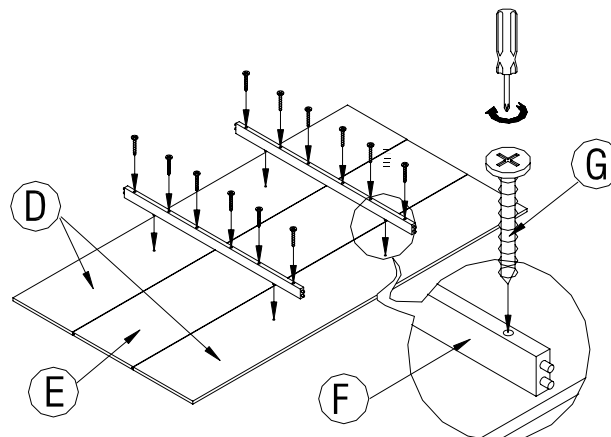

2. Attach the Long siderail w/o profile (A) to Short siderail (C) using Long bolt (I) and Barrel nut (J). Repeat Step 2 with the remaining Short side rail (C) and the Long side rail with profile (B). (Fig. 2)

(Fig. 2)

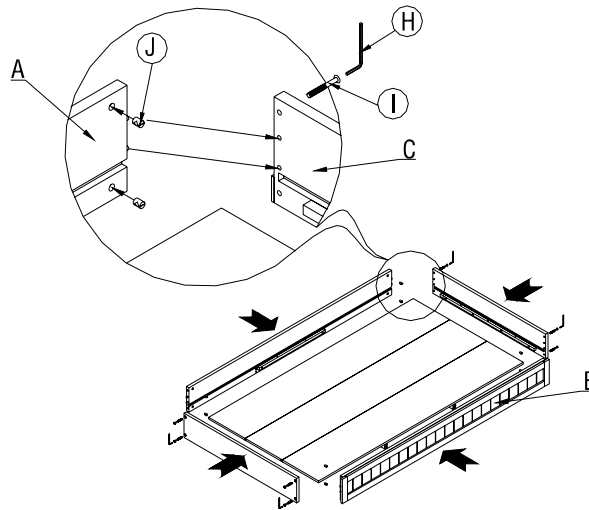

3. Tighten (10) Small Phillips head screws (K) to the assembly as shown. (Fig. 3)
4. Fasten each of the (6) Casters (L) to the bottom corners of the bottom of the assembly with the Pan head screws (M), using the pre-drilled holes as guides. (Fig. 3).

(Fig. 3)

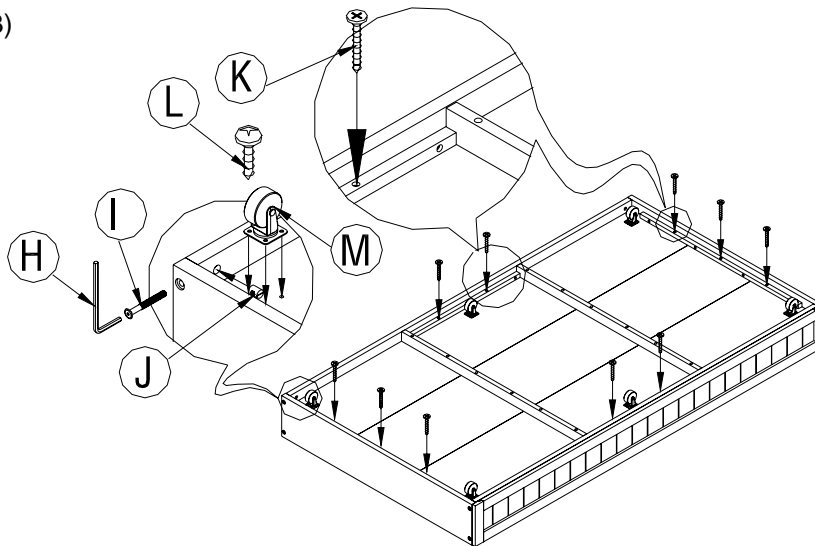

CARE INSTRUCTIONS:

- Dust often using a clean, soft, dry lint-free cloth.
- Blot spills immediately, and wipe with a clean, damp, cloth.
- We do not recommend the use of chemical cleansers, abrasives, or furniture polish on our lacquered finish.
- Do not stand in the trundle.

Thank you for your purchase
stores | catalog | www.potterybarnkids.com
USA 1.800.290.8181