

pottery barn kids

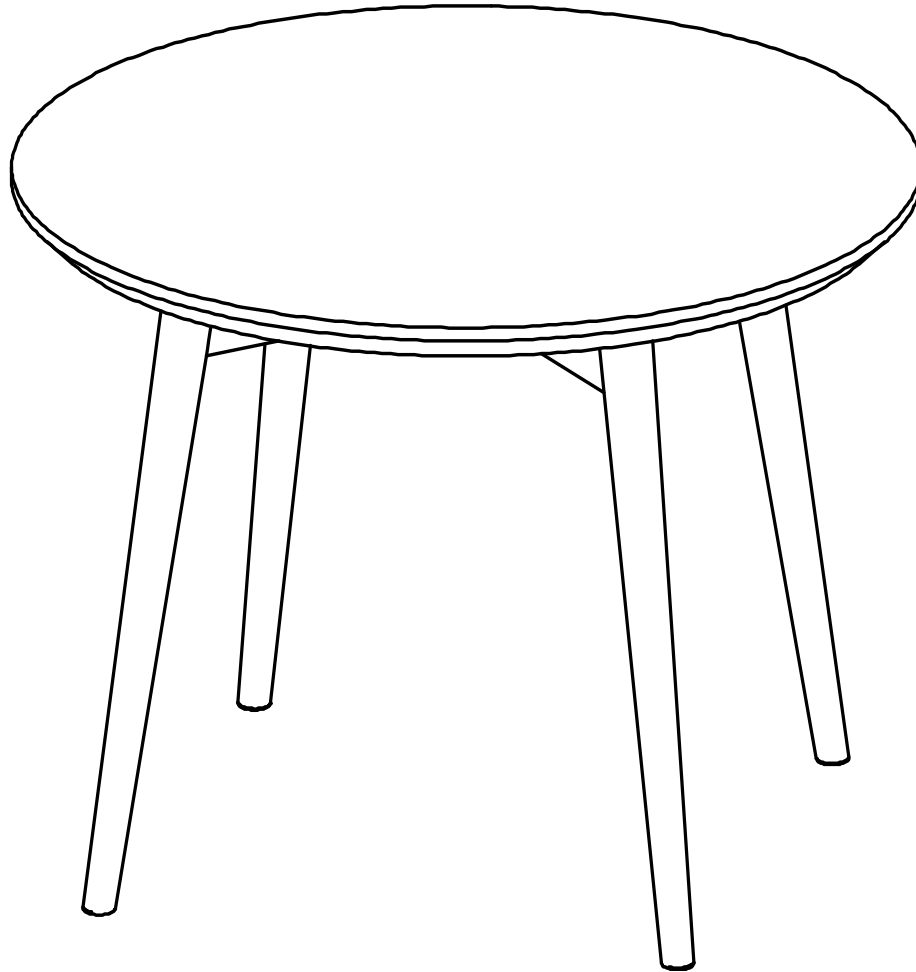

SPINDLE PLAY TABLE

www.potterybarnkids.com

Important Safety Instructions:

- Please read all instructions carefully before assembling.
- For your safety, assembly by two or more adults is strongly recommended.
- Keep these instructions for future use.
- Use only vendor-supplied hardware to assemble this item. Using unauthorized hardware could jeopardize the structural integrity of the item.

Pre-assembly:



- Remove all parts and hardware from the box. Place all items on a carpeted or scratch-free work surface, as this will avoid damaging parts during assembly. The shipping box provides an ideal work surface.
- To avoid accidentally discarding small parts or hardware, do not dispose of any packaging or contents of the shipping carton until assembly is complete.
- Use the parts and hardware lists below to identify and separate each of the pieces included.
- The illustrations provided allow for easier assembly when used in conjunction with the assembly instructions.
- The use of power tools to aid in assembly is not recommended. Power tools can damage the hardware and split the wood.

Parts Included:

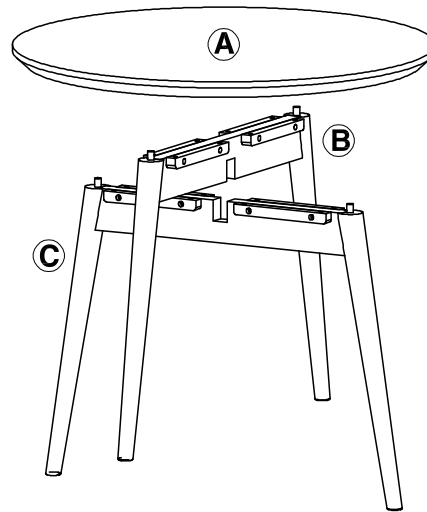
- (A) Top Panel (1x)
- (B) Leg with Bottom Cut-out (1x)
- (C) Leg with Top Cut-Out (1x)





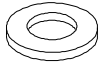

Hardware Included:

 (D) Allen Key – 1x	 (E) Bolt 1/4"x28mm – 16x	 (F) Spring Washer – 16x
 (G) Flat Washer – 16x		

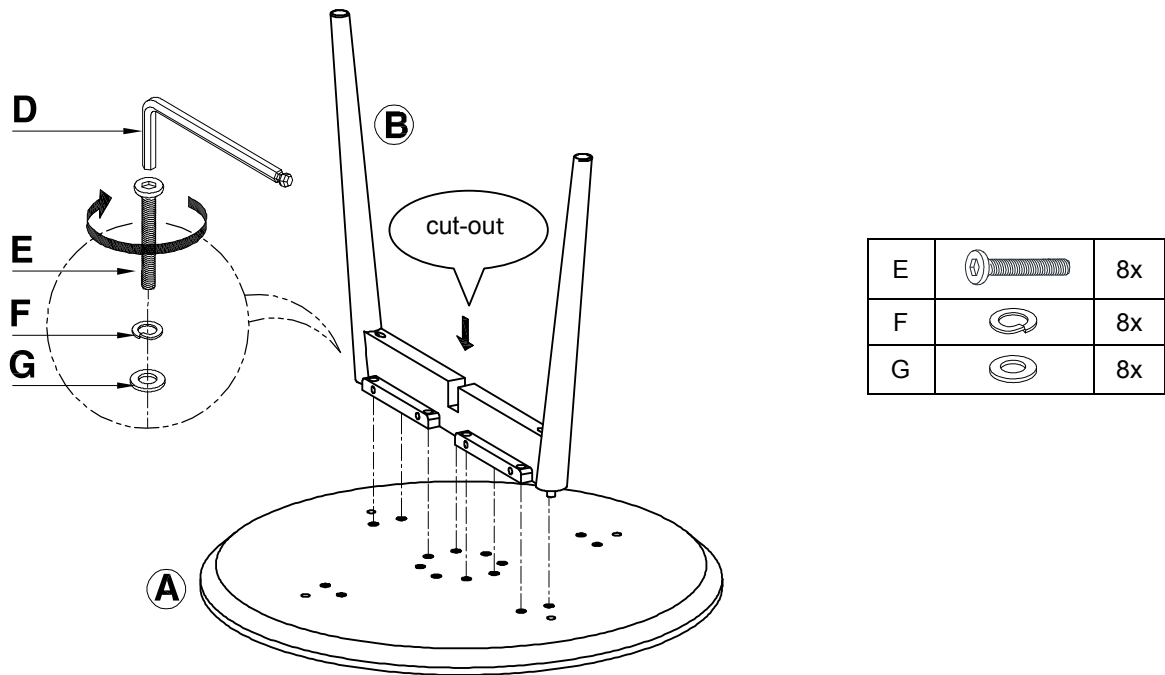
Assembly Instruction Steps:



1. Place (A) upside down on a soft, scratch free surface.
2. Attach (B) to (A) with wooden dowels and pre-drilled holes aligned.
3. Insert 8 sets (E), (F) and (G) through pre-drilled holes on the leg rail into metal inserts pre-installed on the top panel using (D). Do not fully tighten.

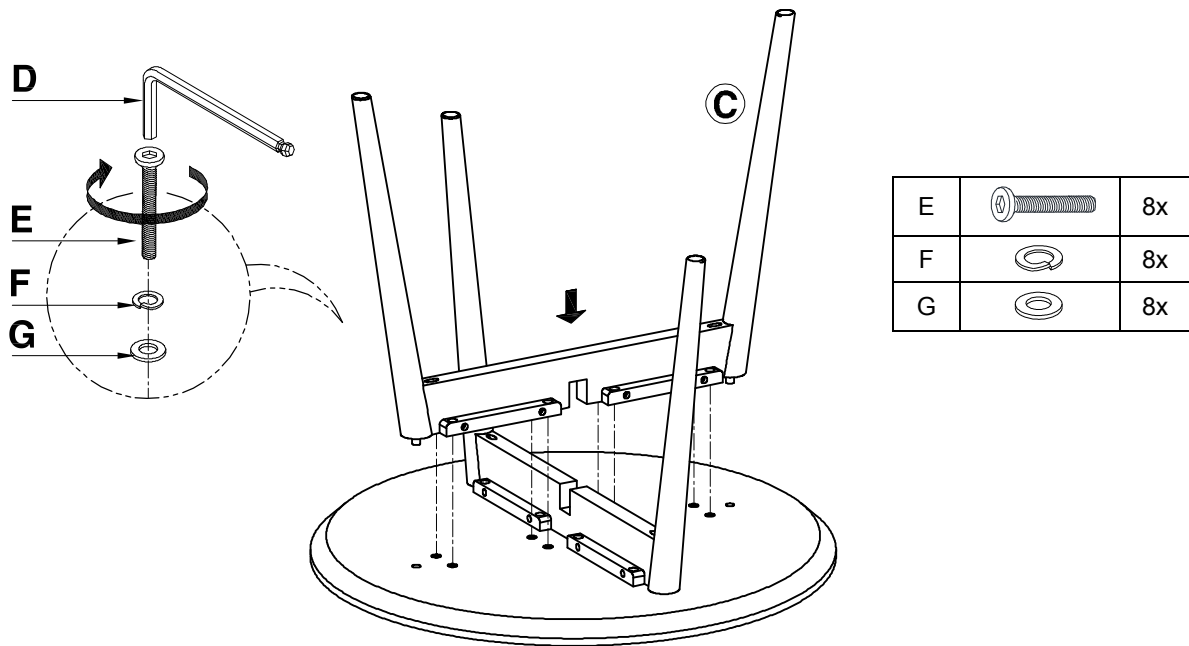

E		8x
F		8x
G		8x

- Attach (C) to the assembled piece with wooden dowels and pre-drilled holes aligned as shown below.
- Insert 8 sets (E), (F) and (G) through pre-drilled holes on the leg rail into metal inserts pre-installed on the top panel using (D).
- Check alignments and tighten all connecting bolts.



E		8x
F		8x
G		8x

Care Instructions:

- Dust often using a clean, soft, dry, and lint-free cloth.
- Blot spills immediately and wipe with a clean, damp cloth.
- We do not recommend the use of chemical cleansers, abrasives, or furniture polish on our lacquered finish.
- Hardware may loosen over time. Periodically check to make sure all connections are tight.
Re-tighten if necessary.

Thank you for your purchase
 Stores | catalog | www.potterybarnkids.com
 USA 1.800.290.8181