

Pottery barn kids

Boat Sandbox Base

CAUTION : Adult assembly required. This item contains small parts in the unassembled state and care should be taken in the unpacking and assembly of the product.

PRE-ASSEMBLY:

- Read all instructions before beginning assembly. The illustrations provided allow for easier assembly when used in conjunction with the assembly instructions.
- For your safety and ease, assembly by two adults is recommended.
- Remove all part and hardware from the box and lay out on a clean, carpeted, or scratch- free work surface. Use care as some parts or hardware may have sharp points or edges.
- Do not dispose of any contents until assembly is completed to avoid accidentally discarding small parts and hardware.
- Use the parts and hardware lists to identify and separate each of the pieces included.
- Note: Do not fully tighten all bolts until all parts are in place. Failure to follow these instructions may cause the bolts misalign during assembly.
- The use of power tools for assembly is not recommended. Power tools can damage hardware or split wood.

Parts included:

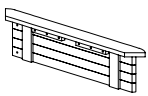

(1) Right Front Frame - A

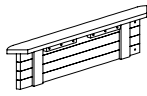

(1) Left Front Frame - B

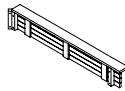

(1) Right Side Frame - C

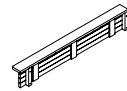

(1) Left Side Frame - D

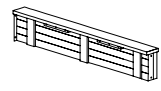

(1) Back Frame - E

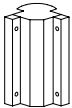

(1) Connector - F



(1) Support - G



(1) Steering Wheel - H

Hardware included :



(10) 1-1/4" Bolt - I

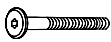

(1) 2-3/4" Bolt - J



(1) Nut - K



(3) Washer - L



(4) 1-1/2" Bolt - M



(1) 4mm Allen Wrench - N



(1) 5mm Allen Wrench - O



(1) Wrench - P

Assembly Instruction :

Step 1: Attach Right Front Frame (A) and Left Front Frame (B) to Connector (F) using Bolts (I), tighten by Allen Wrench (N). see Fig.1

Fig.1

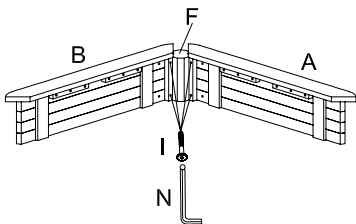

Step 2: Attach Right Side Frame (C) and Left Side Frame (D) to Right Front Frame (A) and Left Front Frame (B) using Bolts (M), tighten by Allen Wrench (N). see Fig. 2

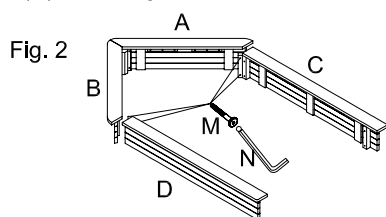

Pottery barn kids

Boat Sandbox Base

Step 3: Attach Back Frame (E) to Right Side Frame (C) and Left Side Frame (D) using Bolts (I), tighten by Allen Wrench (N). see Fig.3

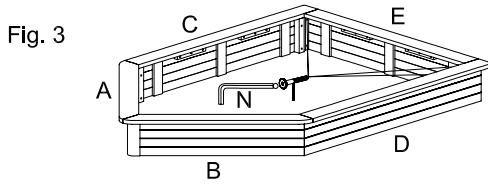

Step 4: Attach Support (G) to the assembled frame using Bolts (I), tighten by Allen Wrench (N). see Fig. 4

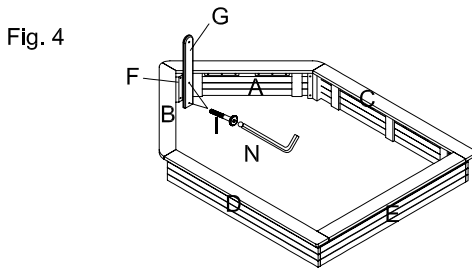

Step 5: Attach Steering Wheel (H) to the support (G) using Bolts (J), Washers (L) and Nut (K), tighten by hand at first. Tighten nut securely with wrench (P) and bolt with Allen wrench (O), but do not over tighten it.

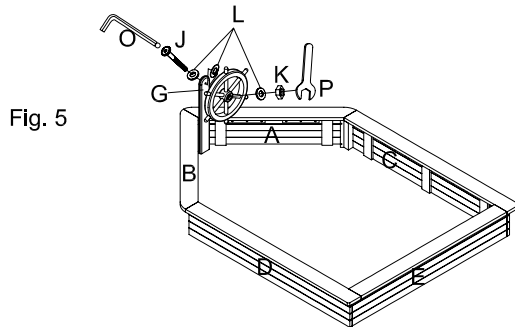

Step 6: The assembly is now complete.

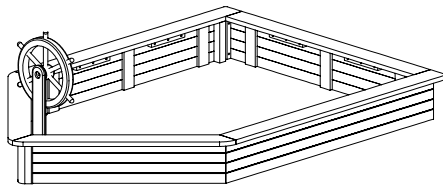

CARE INSTRUCTIONS :

- For daily care wipe with a soft dry cloth. Wipe spills with clean, dry cloth. Avoid the use of harsh cleaners and abrasive.
- Should the finish of outdoor furniture change year over year, apply teak oil or your choice of furniture stain to restore the natural luster and beauty of the wood. For maximum results, we recommend carefully following the labeled instructions for correct applications of the teak oil or furniture stain you choose to purchase.
- Store in a dry, covered area when not in use.

Thank you for your purchase
stores / catalog / www.potterybarnkids.com
1.800.290.8181