

LAGE PLAYHOUSE

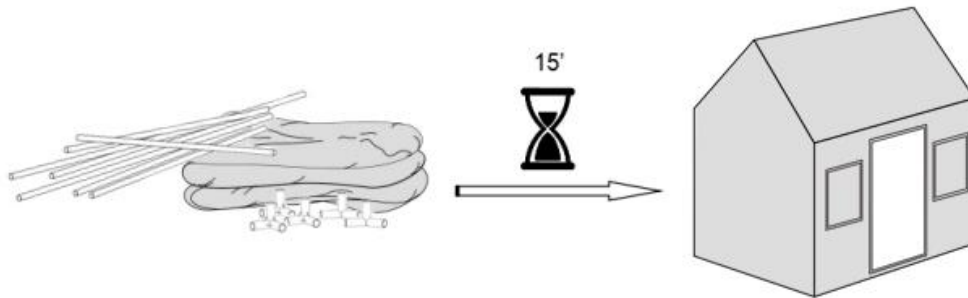

⚠ ENGLISH

- Do not dispose of any packaging or contents of the shipping carton until assembly is completed to avoid accidentally discarding small parts or hardware.

⚠ FRANÇAIS

- Ne jeter aucun emballage ou contenu du carton d'expédition avant que l'assemblage ne soit terminé afin d'éviter de jeter accidentellement des petites pièces ou du matériel.

⚠ ESPAÑOL

- Para evitar desechar accidentalmente las partes pequeñas o las piezas de ferretería, no tirar el embalaje o contenido de la caja hasta que el ensamblaje esté completo.

Care Instructions:

- Keep all flame and heat sources away from this playhouse fabric..
- Designed for 3+ ages kids
- Assembled by adults only.
- To avoid suffocation keep bag away from babies and children. Do not use in cribs, playpens or arriages.

Instructions d'entretien :

- Maintenir ce produit à l'écart de toutes flammes et sources de chaleur.
- Conçu pour les enfants âgés de plus de 3 ans.
- Assemblage par les adultes seulement.
- Afin d'éviter tout risque d'étouffement, tenir le sac hors de portée des bébés et des enfants. Ne pas utiliser dans des berceaux, des parcs ou des landaus.

Instrucciones de cuidado:

- Mantener todas las llamas y fuentes de calor alejadas de esta tela de tienda de campaña.
- Diseñada para niños mayores de 3 años.
- Solamente los adultos pueden realizar el ensamblaje.
- Para evitar asfixia mantener la bolsa alejada de los bebés y los niños. No utilizar en cunas, corralitos o carritos.

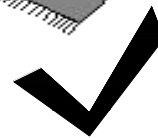
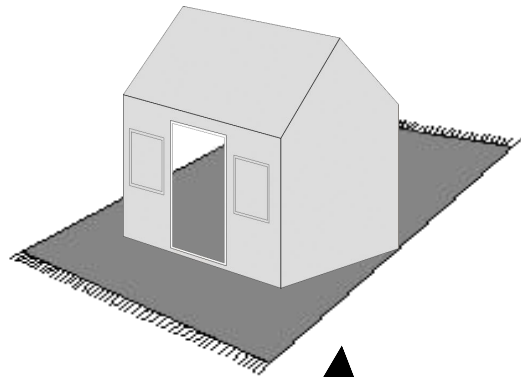
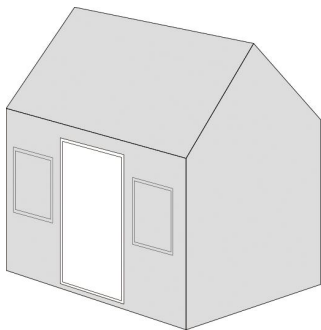
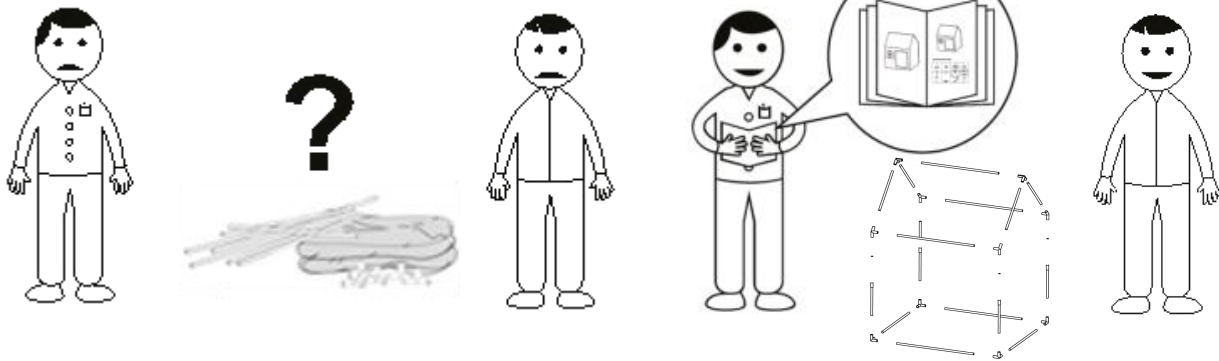
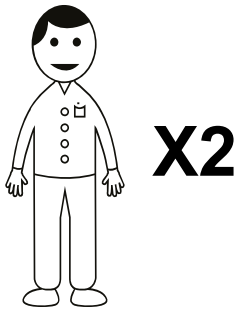

Parts:



(A) 5 pcs



(B) 6 pcs



(C) 4 pcs

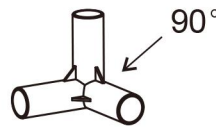

(E) 6 pc

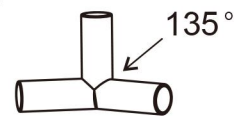

(F) 4 pc

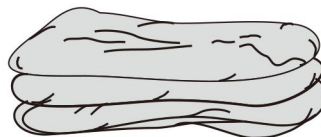

House cloth 1pc

1

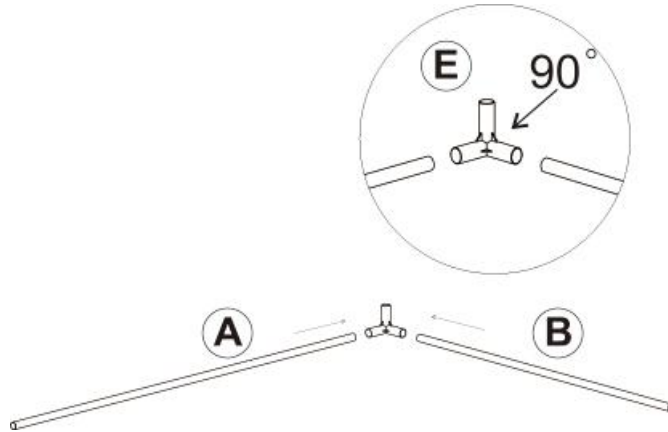

2

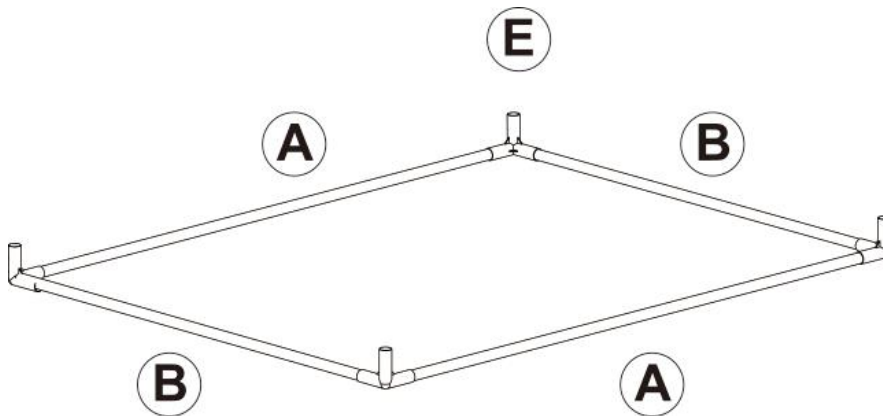

3

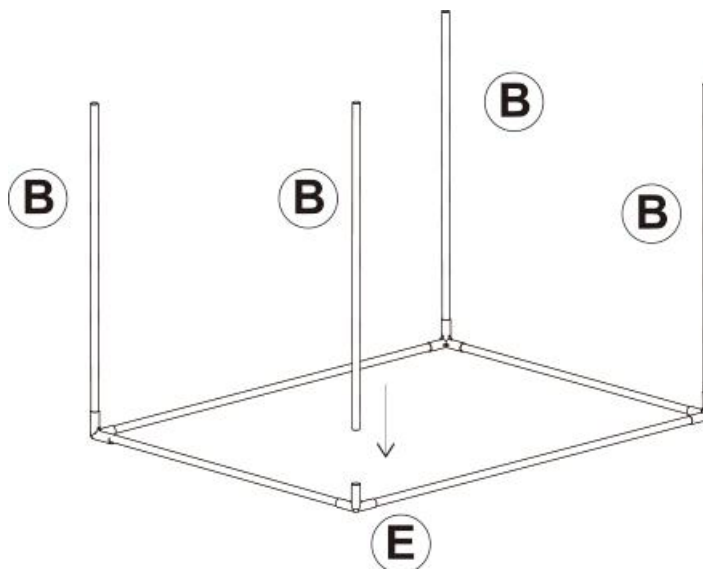

4

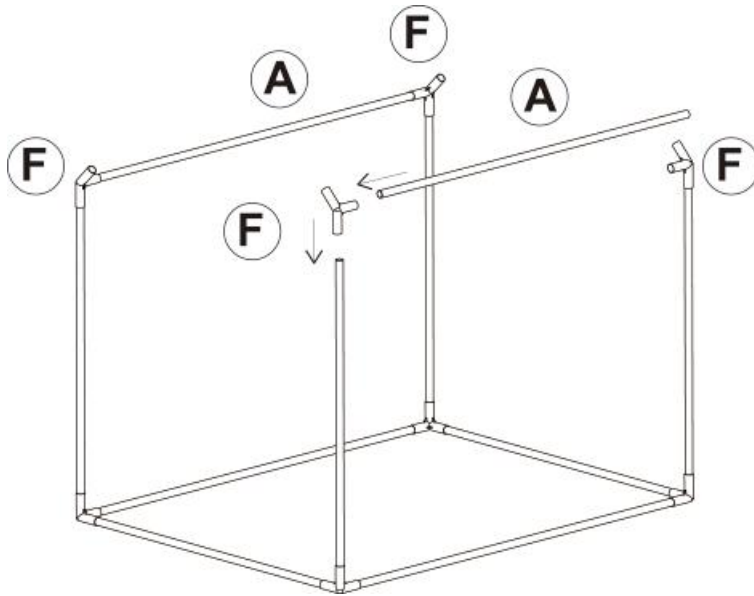

5

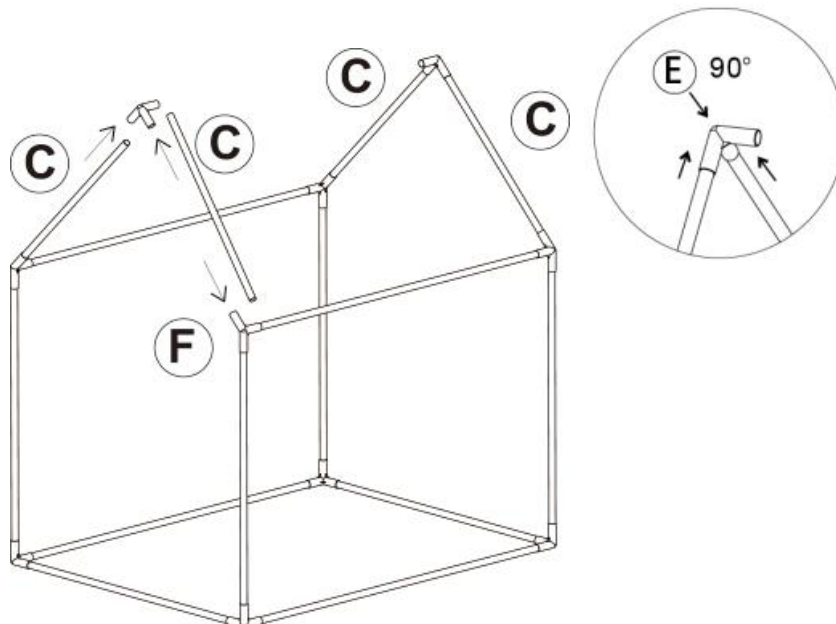

6

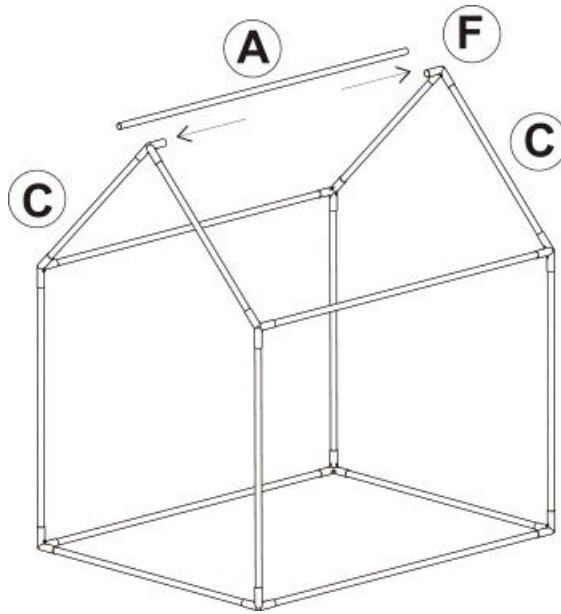

7

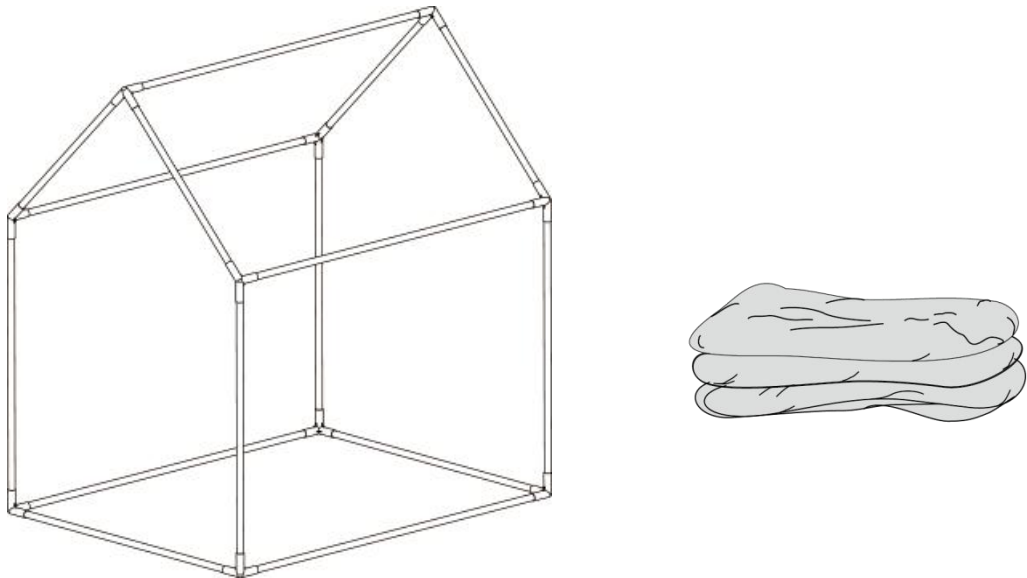

8

